

CLARO-CMOS: a fast, low power and radiation-hard front-end ASIC for single-photon counting in 0.35 micron CMOS technology

Massimiliano Fiorini (Ferrara)

on behalf of

M. Andreotti, W. Baldini, R. Calabrese,
A. Cotta Ramusino, M. Fiorini, E. Luppi,
R. Malaguti, L. Tomassetti

INFN and University of Ferrara



UNIVERSITÀ
DEGLI STUDI
DI FERRARA
- EX LABORE FRUCTUS -

P. Carniti, L. Cassina, A. Giachero,
C. Gotti, M. Maino, G. Pessina

INFN and University of Milano Bicocca



7th International Conference on New Developments In Photodetection

Tours, 30 June – 4 July 2014

- The CLARO-CMOS is an integrated circuit designed for single photon counting with Ma-PMTs
- Main features:
 - 0.35 μm CMOS technology from AMS (\rightarrow low cost, high yield)
 - Counts at 40 MHz (recovery time < 25 ns)
 - Low power consumption ~ 1 mW/channel
 - Settable gain and threshold (8 bits per channel)
- Block diagram:

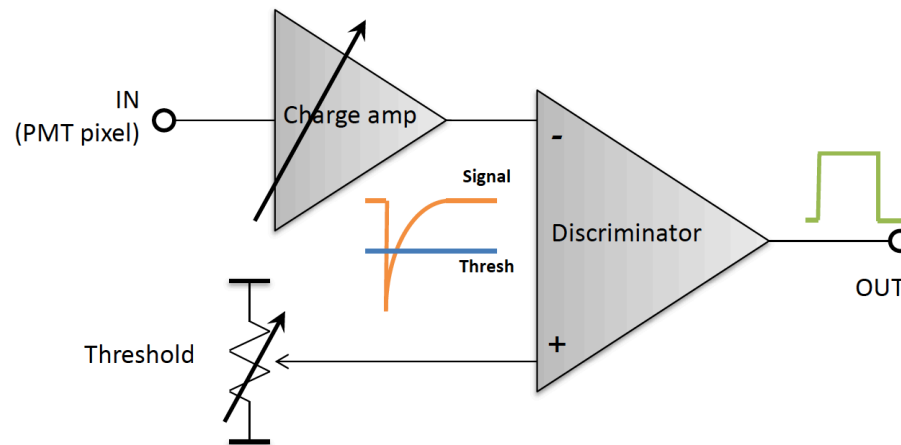

- (2011) ■ The 4 channel prototype CLARO-CMOS was designed
- (2012) ■ Deep characterization on the test bench
 - First tests with R11265 Ma-PMTs and Silicon Photomultipliers
- (2013) ■ Radiation hardness tests with neutrons and X-rays
 - More tests with the R11265 Ma-PMTs
 - Chosen as the baseline front-end ASIC for the LHCb RICH Upgrade
- (2014) ■ Radiation hardness tests with protons
 - The 8 channels version with improvements was designed and received few weeks ago (not described here)

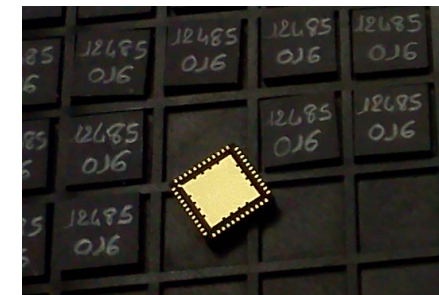
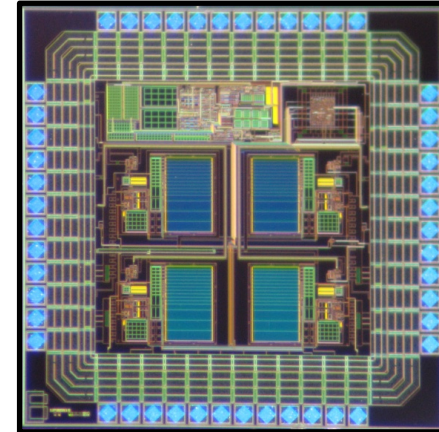

Auxiliary analog output

- The analog output is buffered with a PMOS follower, and is mainly used for debugging
 - It is not meant to be used for single photon counting

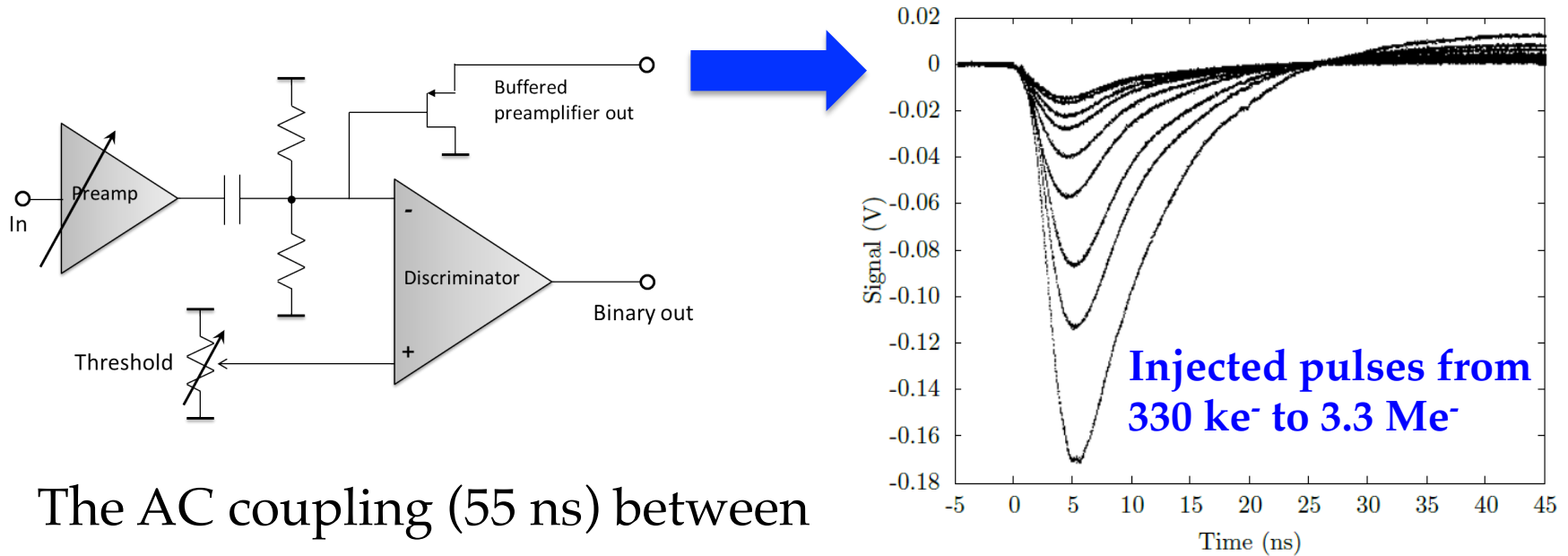

- The AC coupling (55 ns) between the preamp and the discriminator causes the undershoot
- This can result in a threshold shift at high rate (>10 MHz)
- The AC coupling has been removed in the new version of the chip

Main digital output

- Signals at the main (binary) output, for typical Ma-PMT signals at the input (810 ke⁻ to 6.7 Me⁻, threshold set at about 800 ke⁻)

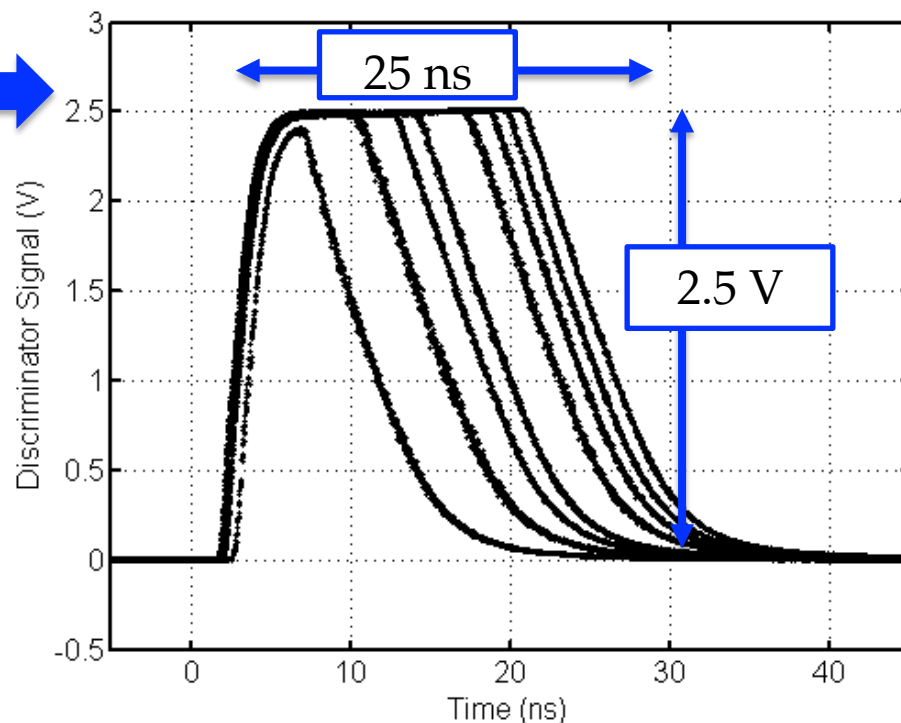
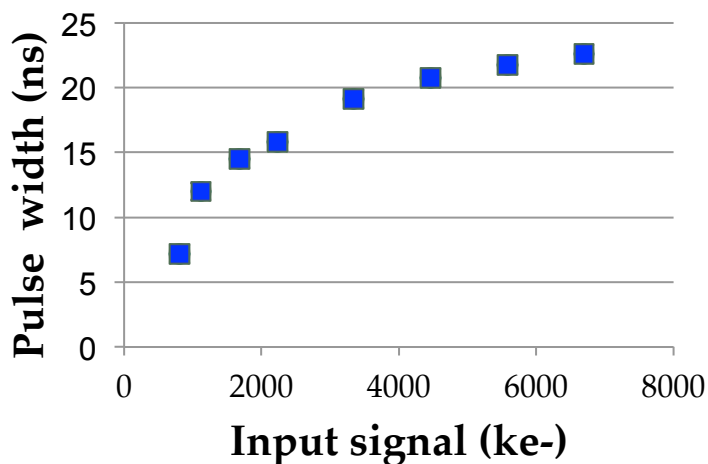
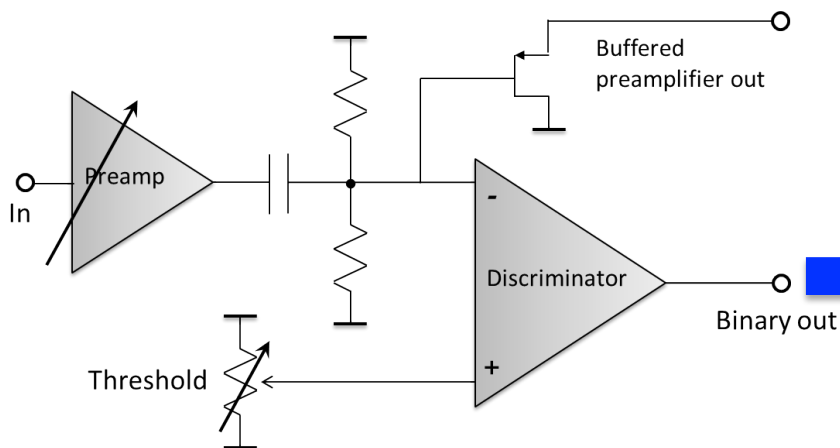

Input capacitance

- The minimization of input capacitance guides the layout of the CLARO PCBs
- Keeping a low number of channels per chip allows to minimize the length of the traces connecting the Ma-PMT pixels to the chip

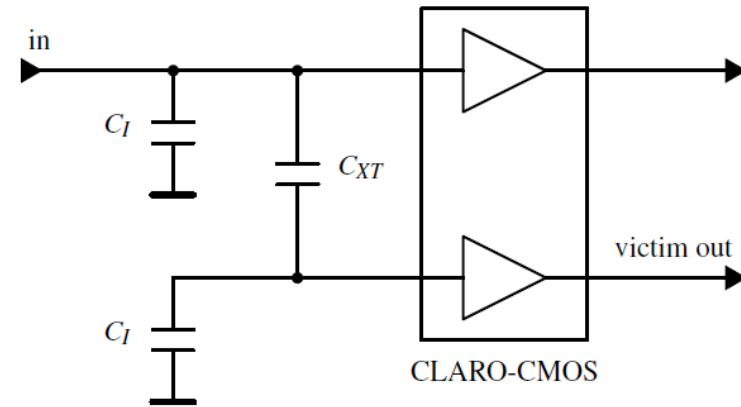

$C_I = 6.5 \text{ pF}$
 $(C_{XT} \sim 0.5 \text{ pF}$
 from Ma-PMT)

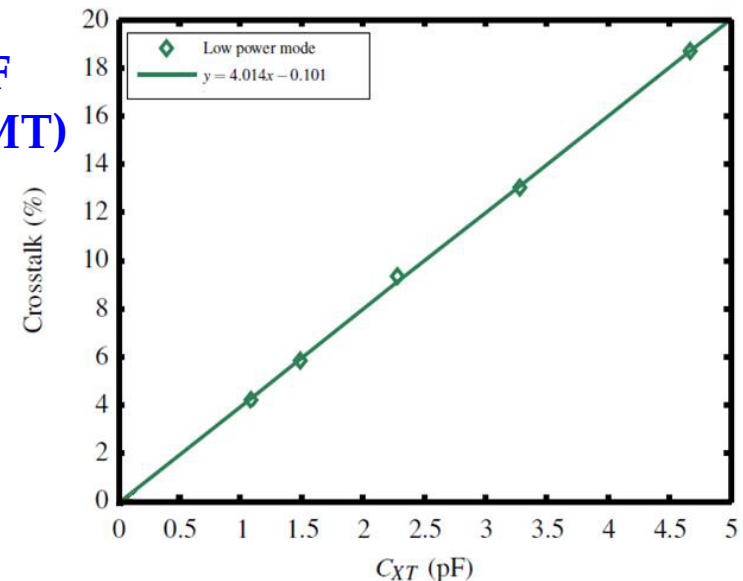
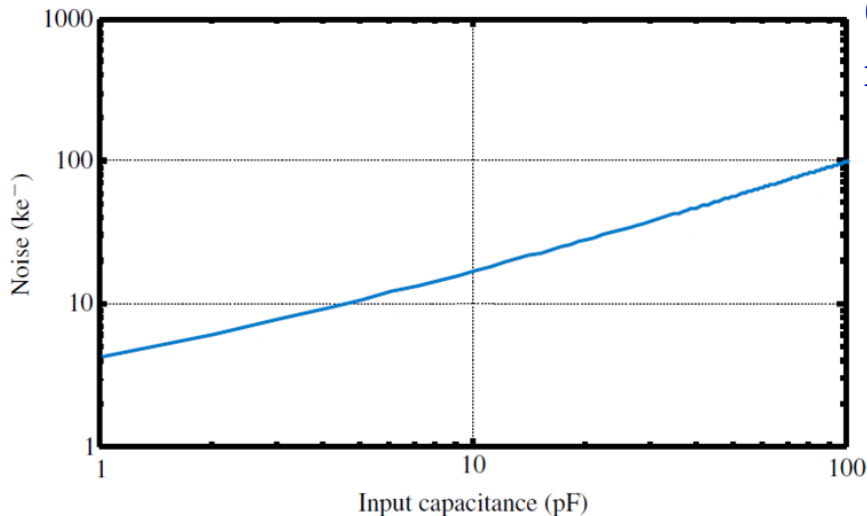

Timing performance

- Excellent timing performance
 - Time walk < 3 ns
 - Leading edge jitter from 110 ps RMS (just above threshold) to 11 ps RMS (large signals)

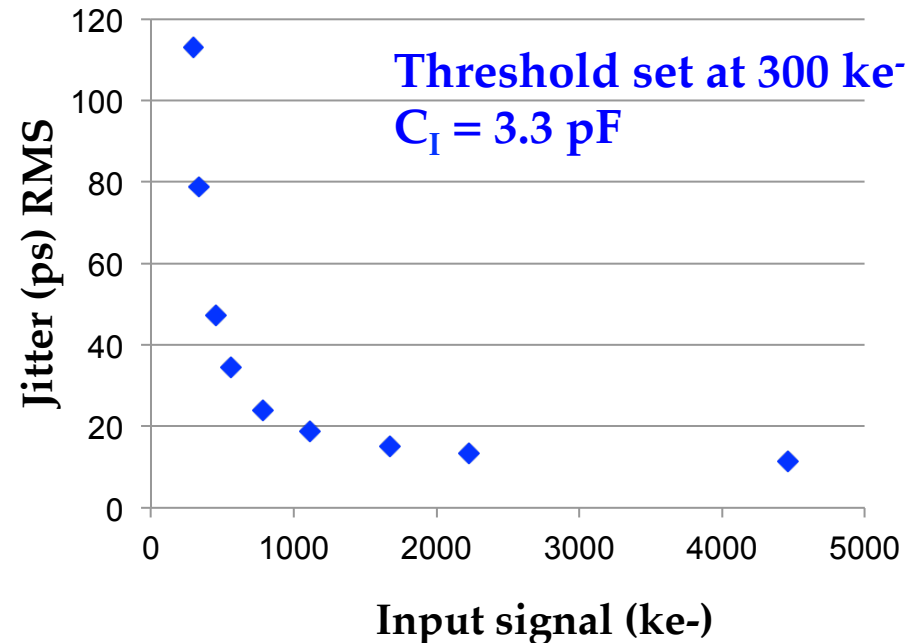
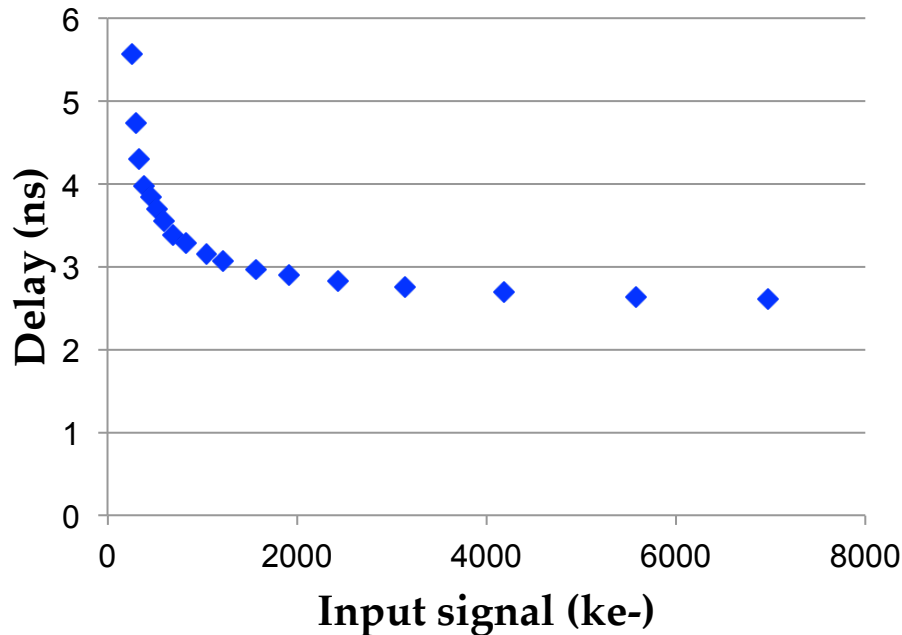

LHCb RICH Upgrade

- The CLARO was chosen (2013) as the baseline front-end ASIC for the **Upgrade** of the **LHCb RICH** detectors (2018-2019)
- The baseline photon sensors are Hamamatsu R11265 Ma-PMTs:
 - Single photon peak at about 1 MeV
 - Gain spread 1:3 between pixels
- Requirements coming from the LHCb environment:
 - Single photon counting at 40 MHz (no dead time at 25 ns) with the R11265 Ma-PMT
 - Radiation hardness up to 10 kGy (1 Mrad) total dose, hadrons up to 10^{13} (n,p) cm⁻²

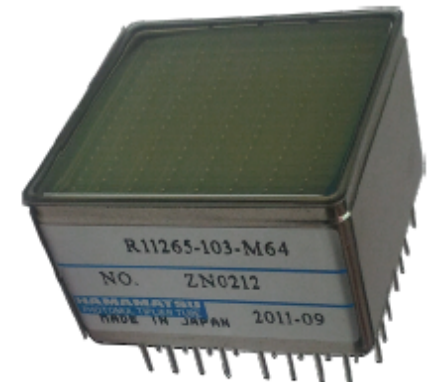
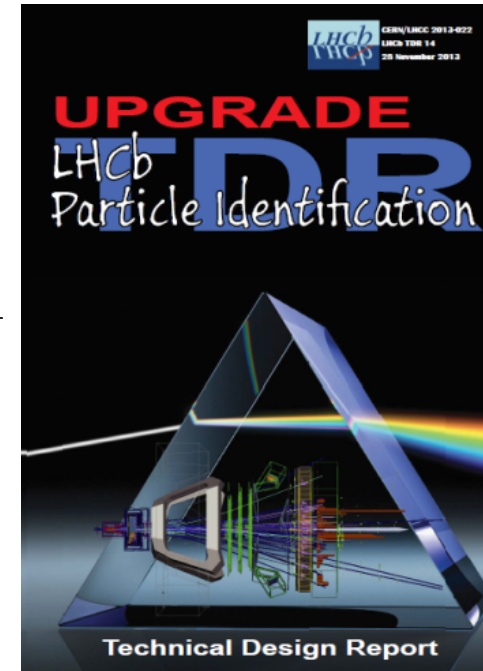

Tests with R11265 Ma-PMT

- A set of PCBs to interface the Hamamatsu R11265 Ma-PMT to the CLARO-CMOS prototype were designed and tested
- The design allows to minimize input capacitance

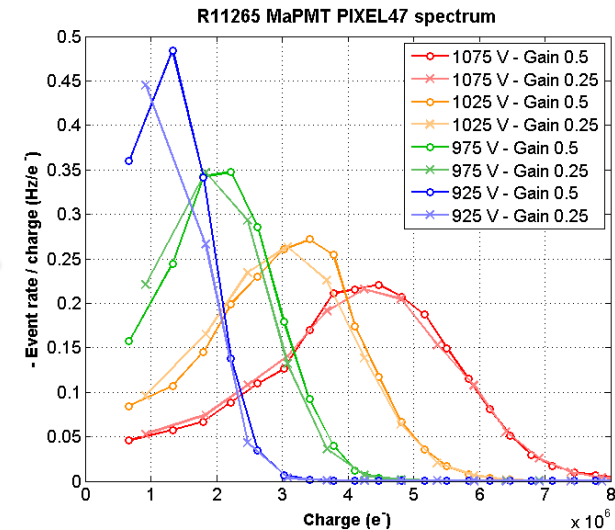
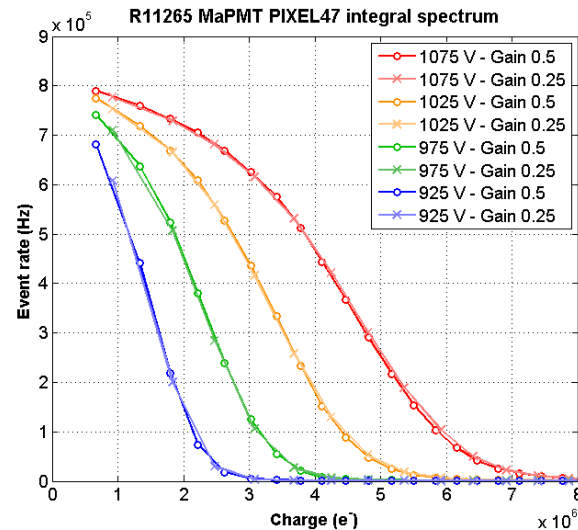
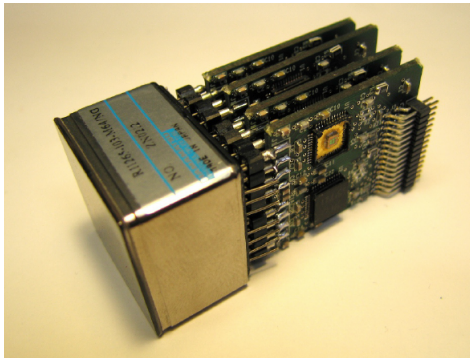

- The single photon spectra of the PMT can be measured by illuminating the PMT with a LED and by counting the signal rates during a CLARO threshold scan
- The new CHIP version features smaller threshold steps

- FLUKA simulation (using current geometry, no safety factor)
 - 1 year (10^7 s), Luminosity $2 \times 10^{33} \text{ cm}^{-2}\text{s}^{-1}$, Cross section: 84 mb
- “Worst-case” values for 1 year running after the Upgrade:

	1 MeV n_{eq} [cm^{-2}]	Hadrons >20 MeV [cm^{-2}]	Dose [Gy]
RICH-1	6.1×10^{11}	2.3×10^{11}	396
RICH-2	3.1×10^{11}	1.0×10^{11}	159

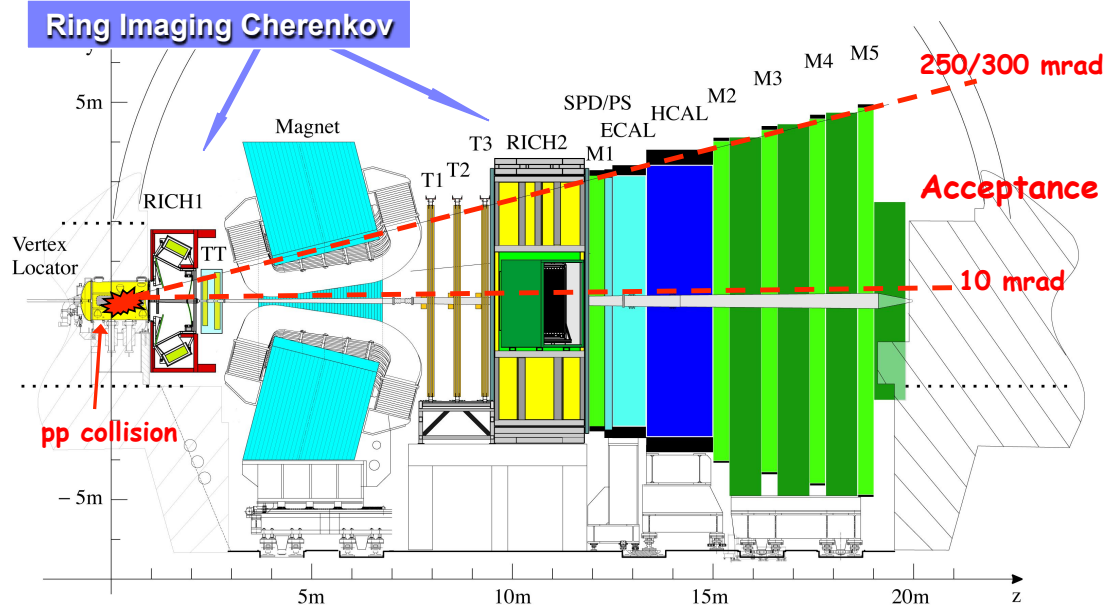

Irradiation Tests

- Printed Circuit Board houses 1 CLARO chip, biased and configured during irradiation
- Measurements during irradiation:
 - Online monitoring of threshold voltage and supply current
- Measurements before / after irradiation:
 - Linearity curves
 - CLARO threshold scan and measurement of threshold voltage
 - S-curves
 - A burst of 1000 pulses sent to all CLARO inputs simultaneously: the number of discriminated output signals is measured for different input signal amplitudes

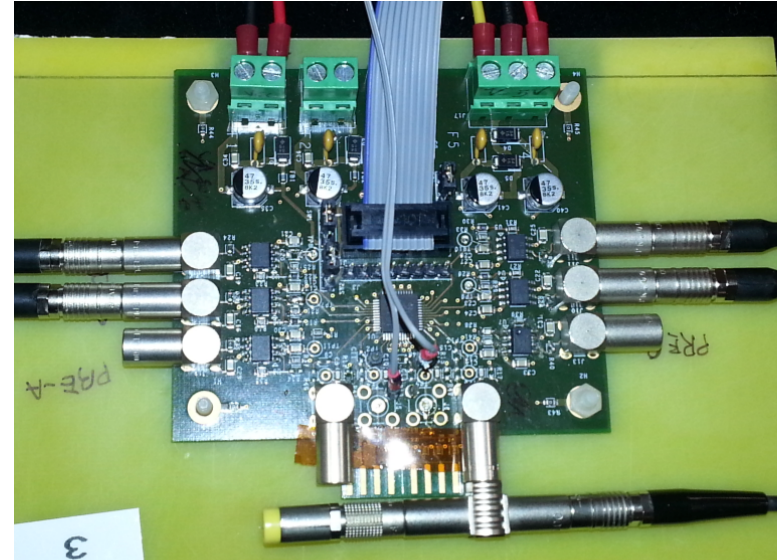

Neutron Irradiation (1)

- Louvain-la-Neuve Cyclotron, 23 MeV n peak energy
 - Low contamination from gamma (2%), p and e (0.02%)
- CLARO chips tested in 3 steps up to 1×10^{14} 1 MeV $n_{\text{eq}}/\text{cm}^2$ (corresponding to ~ 160 LHCb years)
 - Intermediate steps at $\sim 10^{12}$ and $\sim 10^{13}$ $n_{\text{eq}}/\text{cm}^2$
 - A few samples irradiated in cascaded configuration

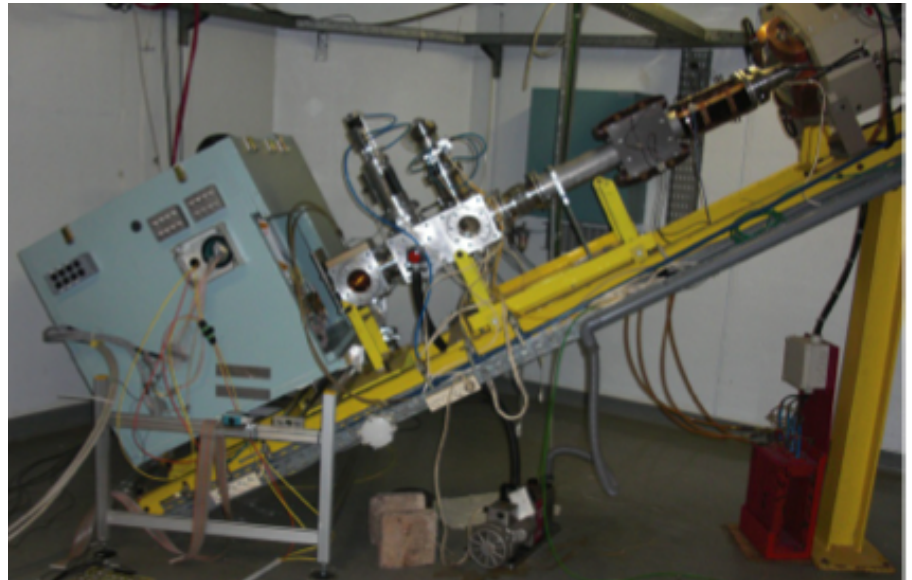
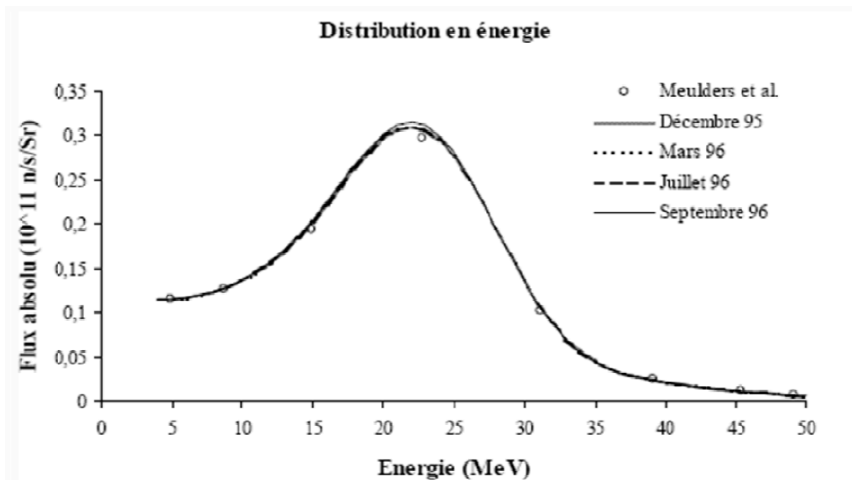

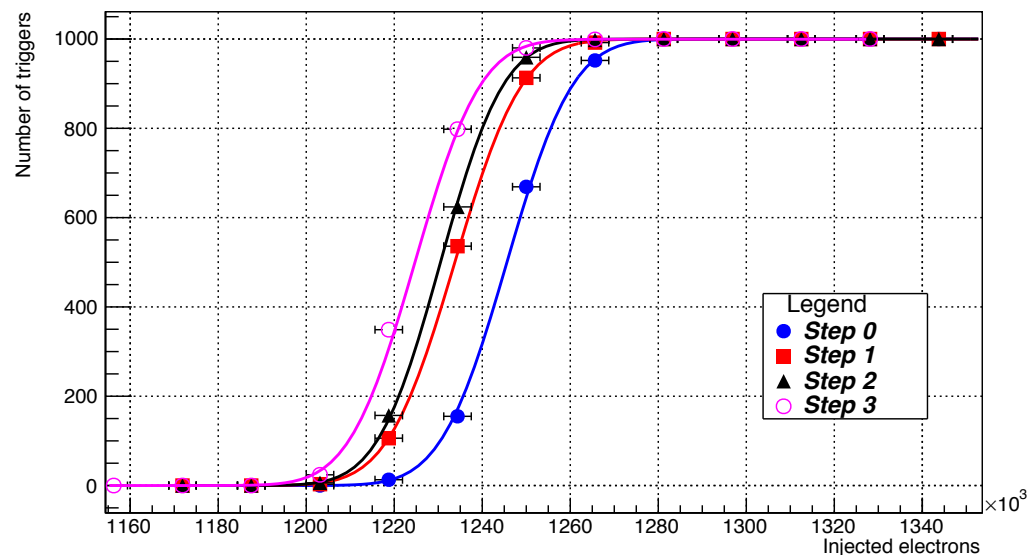
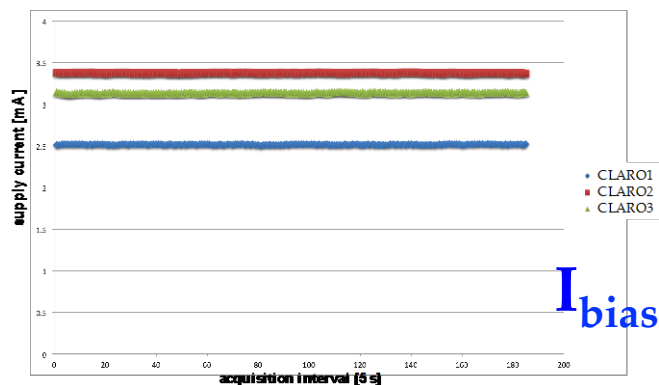
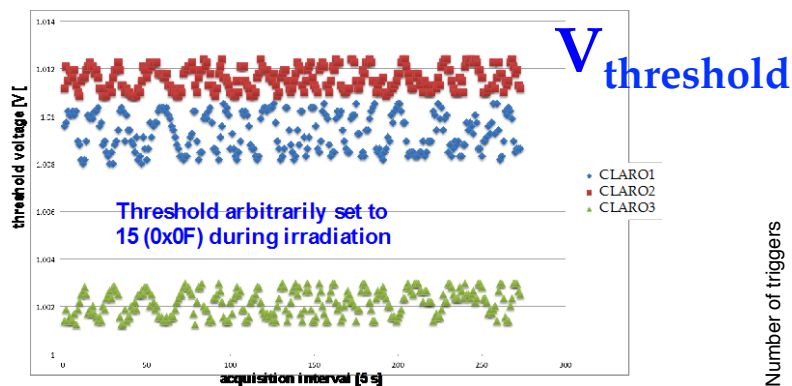

- No SEU / SEL observed
- No variation in supply current
- No significant variation in thresholds and noise (few %)

X-ray Irradiation (1)

- INFN Laboratories in Legnaro
- Tube with W anode (7.4-12.06 keV L-lines) at 50 kV
- CLARO chips tested in 4 steps up to 8 Mrad dose (corresponding to 200 LHCb years)
 - Intermediate steps at 40 krad, 400 krad, 4 Mrad
 - Few samples irradiated with package lid removed

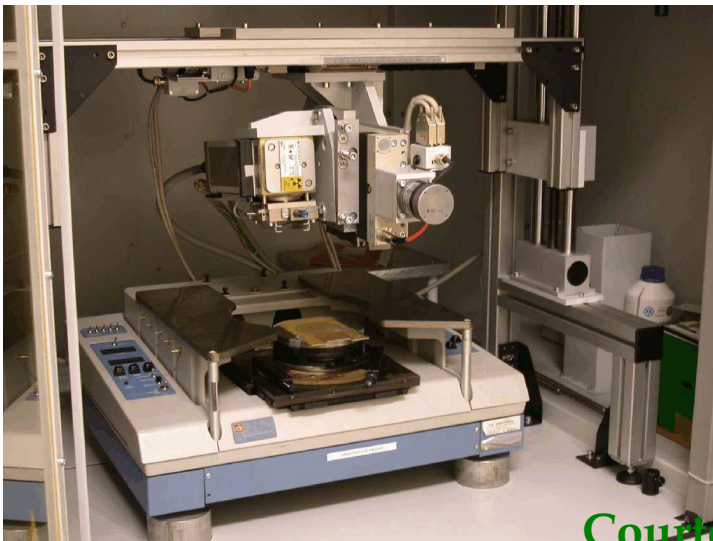

Courtesy of S. Mattiazzo

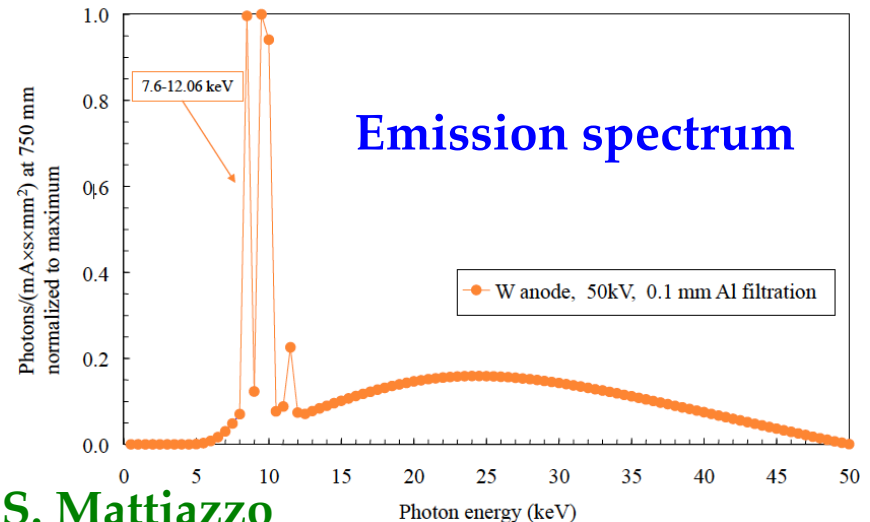

X-ray Irradiation (2)

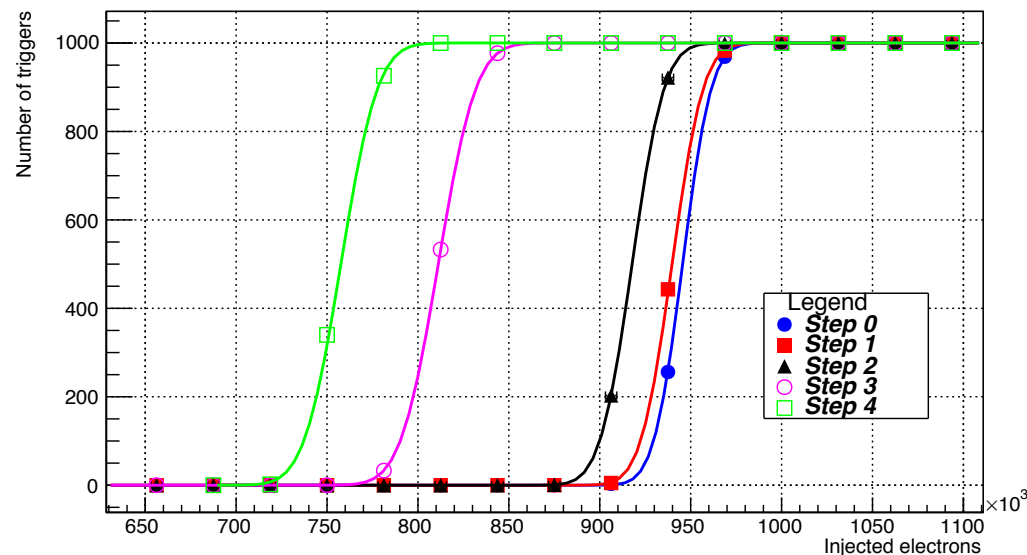
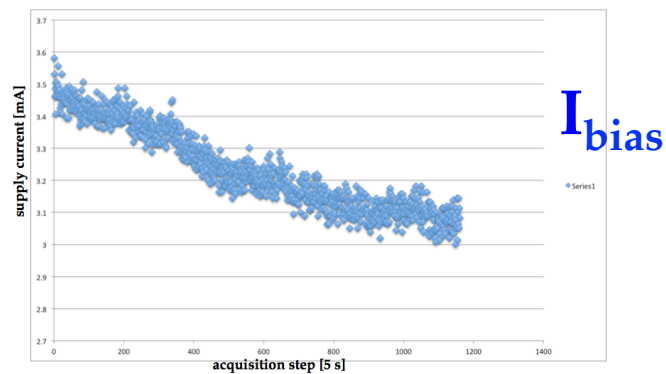
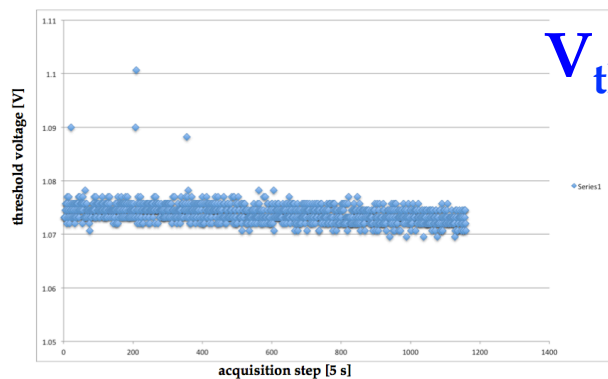

- No SEU / SEL observed
- ~10% variation in supply current
- ~20% variation in thresholds and noise
- Clear threshold variation trend, but well within DAC range

Proton Irradiation (1)

- Institute of Nuclear Physics PAN (Krakow)
- 60 MeV cyclotron (therapy and experimental room)
- CLARO chips tested in 4 steps up to 7.6 Mrad dose (corresponding to 190 LHCb years)
 - Intermediate steps at 40 krad, 400 krad, 4 Mrad
 - Few samples irradiated with package lid removed

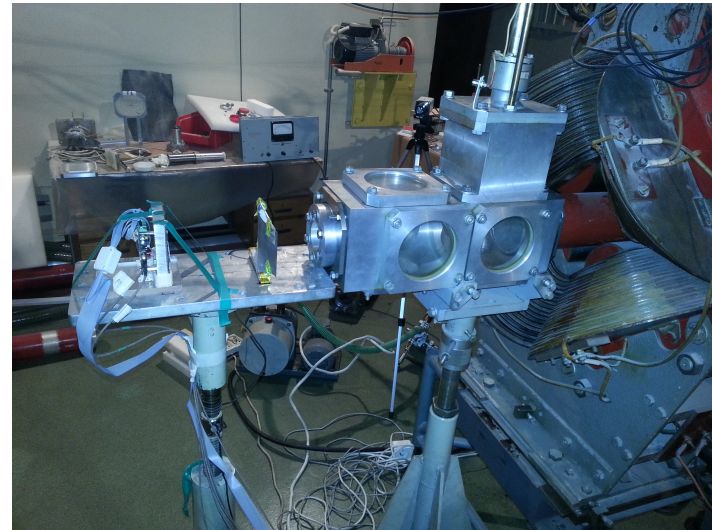
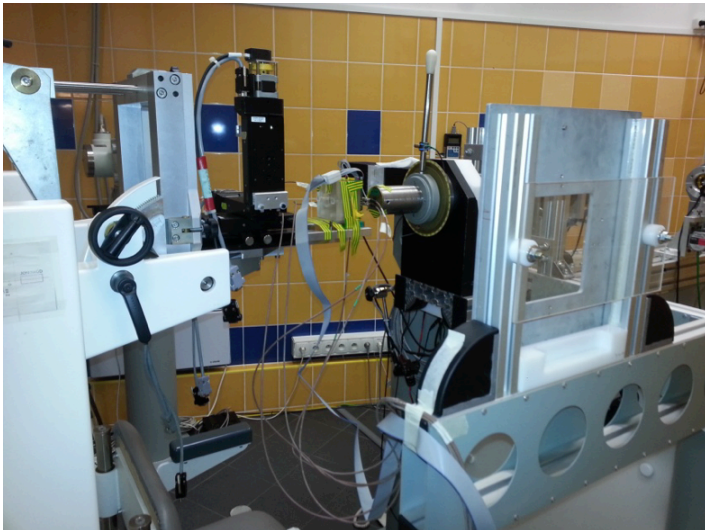

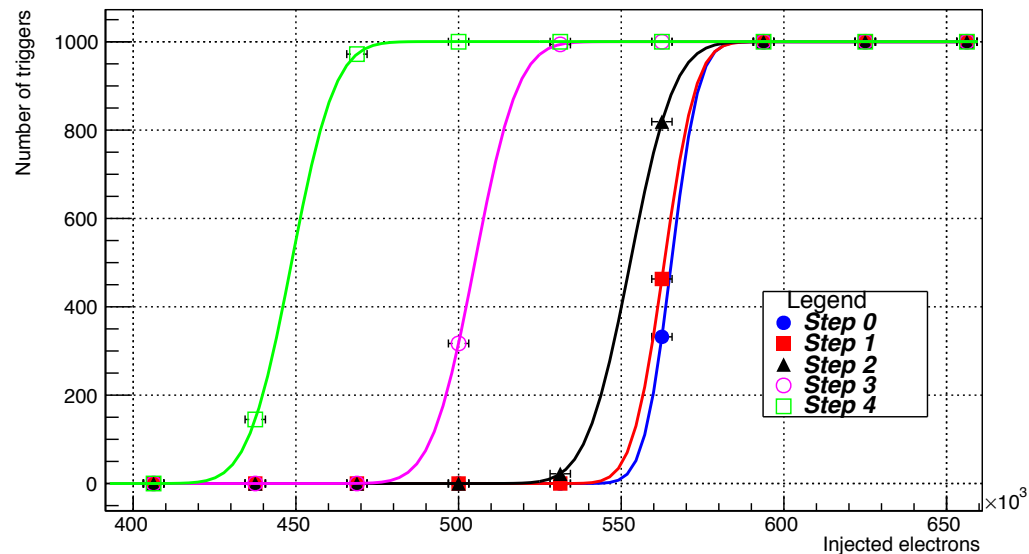
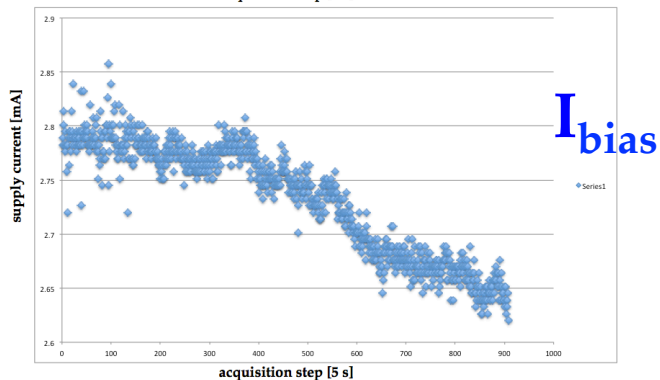
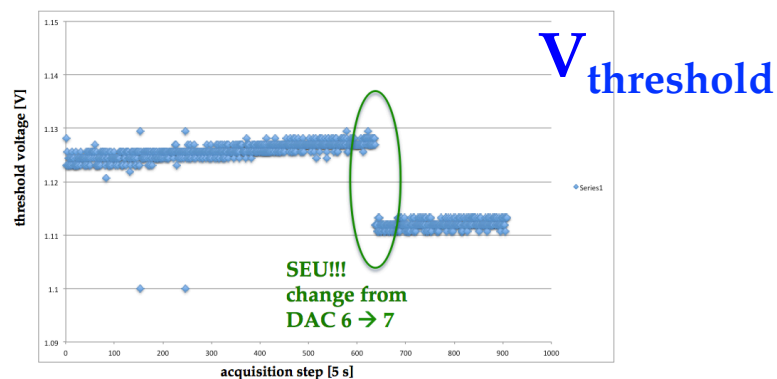

- 1 SEU observed (no SEL)
- ~10% variation in supply current
- ~20% variation in thresholds and noise
 - Clear threshold variation trend, but well within DAC range

- The 4-channel prototype CLARO-CMOS is able to count single photons from Ma-PMTs at a 40 MHz rate with low power consumption (~ 1 mW / channel)
 - Satisfies the requirements as front-end chip for the Upgrade of the LHCb RICH detectors
- The CLARO can work at radiation levels at least one order of magnitude larger than those foreseen in ten years of operation in the upgraded LHCb (8 Mrad total dose and 10^{14} 1 MeV n_{eq} / cm^2)
- In addition, a jitter in the order of tens of ps was demonstrated, enabling the use of the CLARO for precise timing measurements

What's next? CLARO8

- An improved version of the chip with 8 channels (CLARO8) was designed earlier in 2014
- Main features compared to the prototype:
 - Amplifier DC-coupled to the discriminator
 - Finer threshold steps
 - Configuration register protected against SEU by triple modular redundancy
- The first samples were received a few weeks ago and detailed tests are ongoing

SPARES

Test with SiPM

- Test performed with $1 \times 1 \text{ mm}^2$ and $3 \times 3 \text{ mm}^2$ devices
- Signals are slower because of the large input capacitance with respect to the design specification
- Nevertheless, signals corresponding to different numbers of photons can still be resolved

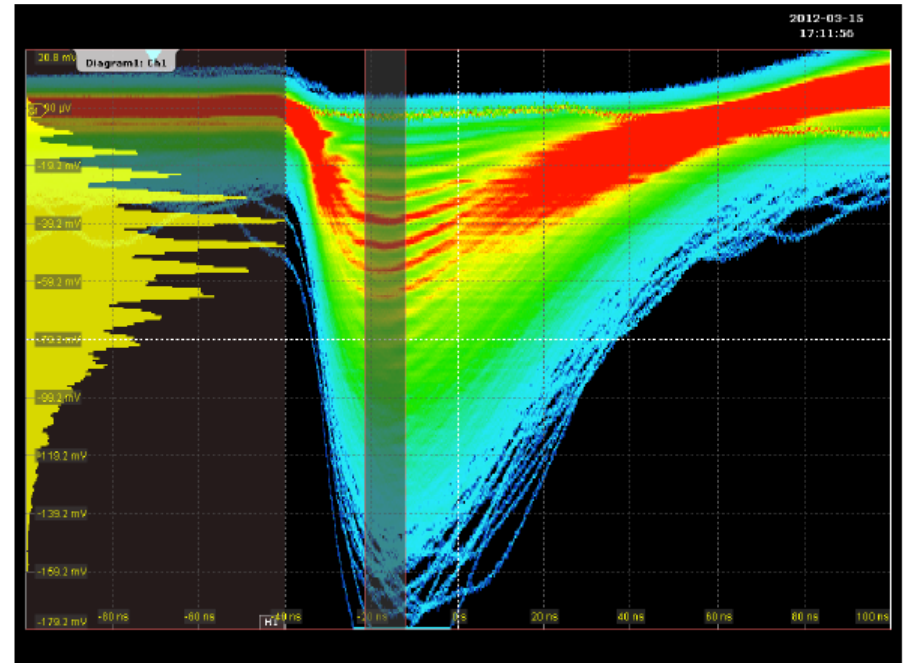
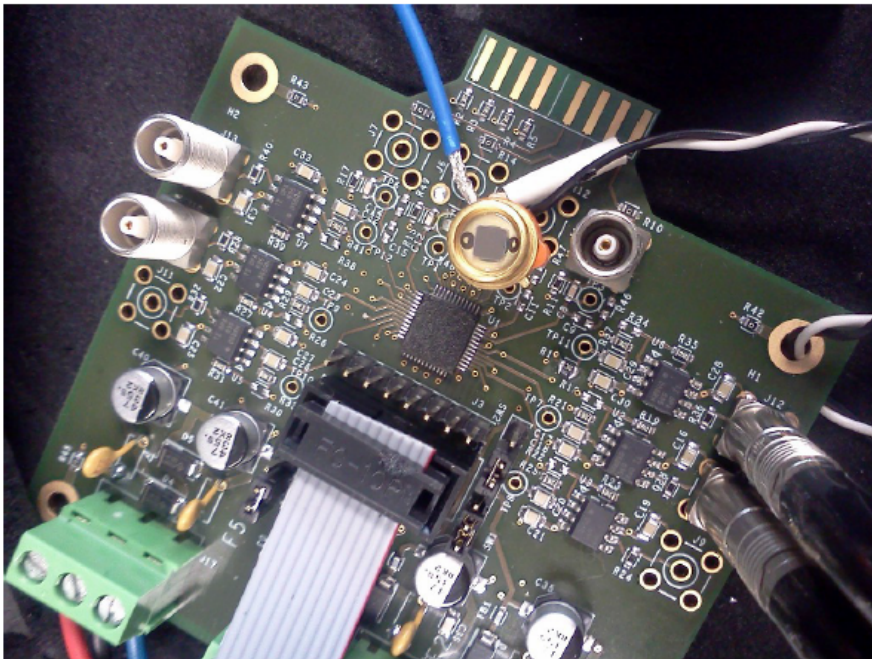

- Current LHC schedule:

end 2009 – 2012 $\sqrt{s}=7$ TeV until 2011, then 8 TeV $\sim 3 \text{ fb}^{-1}$	2013 – 2014 LS1	2015 – 2017 $\sqrt{s}=13$ TeV, 25 ns target $\sim 5 \text{ fb}^{-1}$	2018 – 2019 LS2 18 months
--	--------------------	--	---------------------------------

- Luminosity @LHCb reached $\sim 4 \times 10^{32} \text{ cm}^{-2}\text{s}^{-1}$ ($\mu = 1.6$)
 - $\times 2$ higher than design value ($\mu = 0.4$)
- Plan for an LHCb Upgrade after LS2 \rightarrow fully exploit LHC flavour physics potential (collect 50 fb^{-1} in 10 years)
 - Increase luminosity up to $2 \times 10^{33} \text{ cm}^{-2}\text{s}^{-1}$
 - Upgrade the detector
 - Overcome current limitation of ~ 1 MHz read-out rate \rightarrow substantial change in LHCb trigger and read-out architecture to read the full detector at 40 MHz

[Letter of Intent \(2011\)](#)
[Framework TDR \(2012\)](#)
[PID Upgrade TDR \(2014\)](#)

- Consequences of the Upgrade for the RICH:
 - Replace all photo-detectors
 - 1 MHz read-out electronics is encapsulated within the tube
 - Use commercial Multi anode PMTs (Hamamatsu R11265)
 - Use external front-end electronics and new services
 - New front-end chip CLARO as baseline option
 - Modify RICH-1 optical system
 - Must handle higher detector occupancies
 - Remove aerogel
 - Installation during ~18 months of Long Shutdown 2 (2018-2019)

- Increase focal length of RICH-1 spherical mirrors in order to halve the occupancy

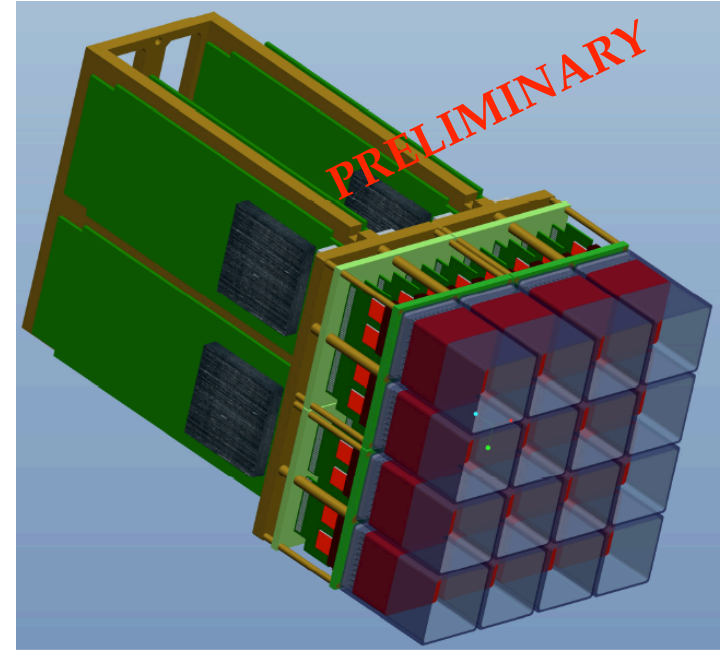
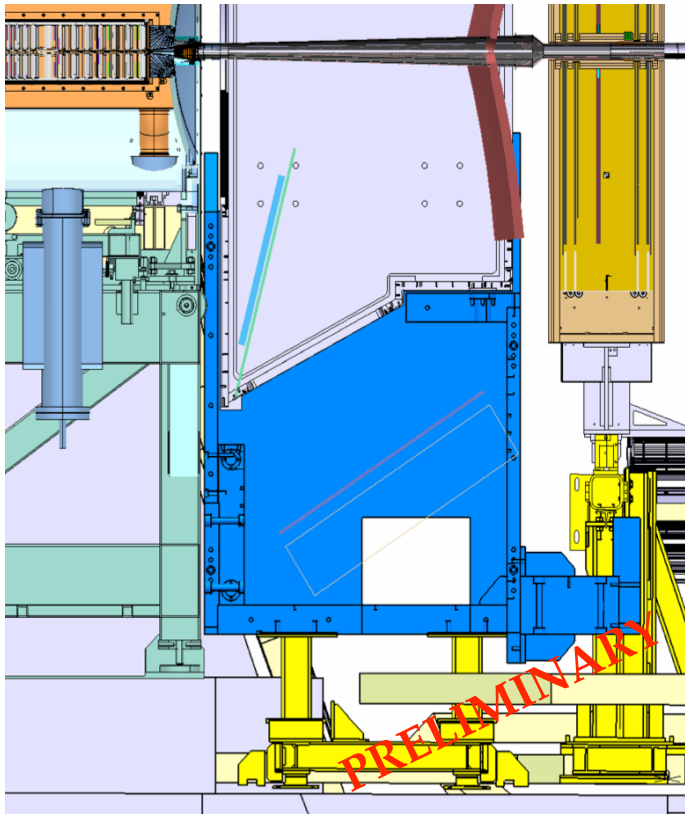

- New Ma-PMT totally modular assemblies
 - A few will be installed in the coming years for characterization